

**Lemi**<sup>®</sup>  
ITALIAN WELLNESS EQUIPMENT



ESSENTIAL

*All the massage tables of the ESSENTIAL line feature the electric height adjustment and the possibility to adjust the back or the leg manually.*

Tutti i lettini della linea ESSENTIAL presentano la regolazione elettrica dell'altezza e la possibilità di regolare lo schienale o la gamba manualmente.



\* B: Rovere Axe 4208 | M: Nefos 1155



Backrest with face hole / Schienale con foro viso

Adjustable height / Altezza regolabile

**COD. 855**

*Featuring an electric base adjustment and a 2 section mattress with face hole. Ensuring an easy client access while ensuring an optimal work posture for the practitioner.*

*IDEAL FOR: massages, face and body treatments, hair removal, treatments with aesthetic equipment.*

Dotato di regolazione elettrica dell'altezza e di un materasso a 2 sezioni con foro viso. Garantisce un accesso facile al cliente e al tempo stesso una postura di lavoro ottimale per l'operatore.

IDEALE PER: massaggi, trattamenti viso e corpo, depilazione, trattamenti con apparecchiature estetiche.

*\* The images are for illustrative purposes only and may not reflect the actual image of the finishing.*

*\* Le immagini hanno valore puramente illustrativo e possono non rispecchiare l'immagine reale della finitura.*

**Focus on**

- 1 Motor for height adjustment
- Backrest with gas-spring adjustment
- 2 sections mattress with face hole
- Painted metal base
- Maximum client / practitioner comfort

- 1 motore per la regolazione dell'altezza
- Schienale regolabile mediante molla a gas
- Materasso a 2 sezioni con foro viso
- Base di metallo verniciata
- Massimo comfort cliente / operatore

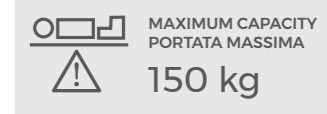
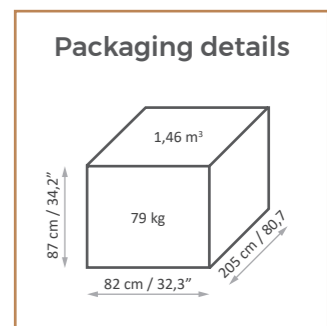
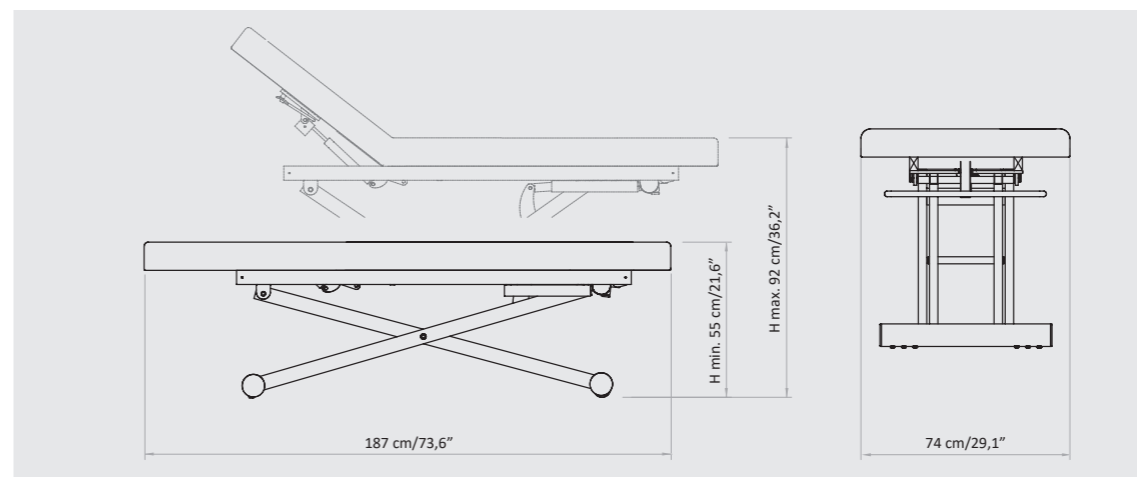

# MATTRESS CUSTOMIZATION PERSONALIZZAZIONE MATERASSO

VITA - COLOR CHART

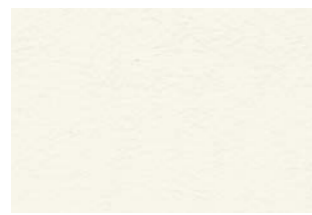

EV00021



EV00022



EV00041



EV00042

SPA PRESTIGE - COLOR CHART



9916

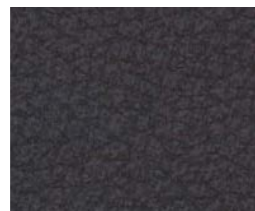

1424

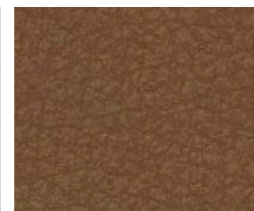

1423

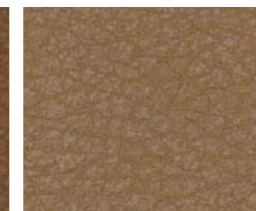

1422

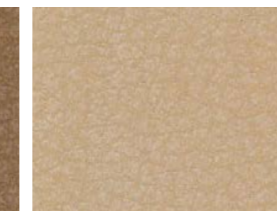

2202



2204



7022



7023



1875

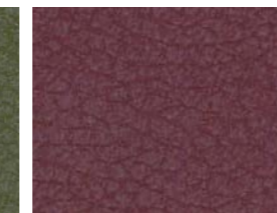

1530

NEFOS - COLOR CHART

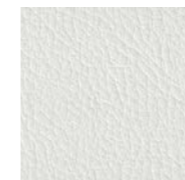

6

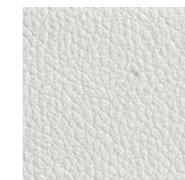

1957



6985



3962

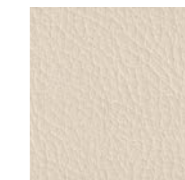

1155

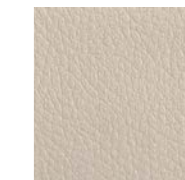

2124



1194



2173



6986



569

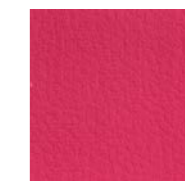

667



680



64



71

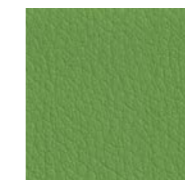

1868



1843



8019

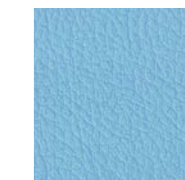

8009



5946



6940



6941



6942



1388

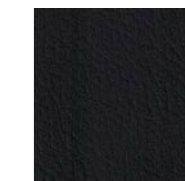

991

The images are for illustrative purposes only and may not reflect the actual finish of the product, particularly when viewed through a screen. Therefore, the **SELECTION OF THE FINISHES** of the **BASES** and **MATTRESS FABRICS** must take place **AFTER CONSULTING** the **LUXURY BOX PHYSICAL SAMPLES** and the **COLOR CHARTS**.

The innovative VITA (consisting of 80% natural and renewable components), Spa Prestige and Nefos materials - which are exclusive for LEMI products - and their special finishing touch guarantee easy-cleaning and hygiene. Their extraordinary structural qualities will persist through the years. An incredibly elastic texture enhances the memory foam mattress softness and quality at its best, giving Spa Clients a complete and satisfying wellness experience.

Gli innovativi materiali VITA (costituiti per l'80% da componenti naturali e rinnovabili), Spa Prestige e Nefos - che sono un'esclusiva dei prodotti LEMI - ed il loro speciale tocco di finitura garantiscono una facile pulizia e igiene. Le loro straordinarie qualità strutturali permangono nel corso degli anni. Una texture incredibilmente elastica migliora al massimo la morbidezza e la qualità del materasso in Memory Foam, dando ai clienti Spa un'esperienza di benessere completa e soddisfacente.

Le immagini hanno valore puramente illustrativo e possono non rispecchiare la finitura reale del prodotto, in particolare se visualizzate attraverso uno schermo. Pertanto la **SELEZIONE DELLE FINITURE** delle **BASI** e dei **RIVESTIMENTI** dei **MATERASSI** deve avvenire **PREVIA CONSULTAZIONE** della **CAMPIONATURA FISICA** della **LUXURY BOX** e delle **CARTELLE COLORI**.

# BASE CUSTOMIZATION PERSONALIZZAZIONE BASE

## METAL FINISHES



White metal  
Metallo bianco verniciato

We provide a solid base completely realized in metal, made within our company. The result is a very strong material that is scratch resistant and easy to clean.

Forniamo una base solida completamente in metallo, realizzata all'interno della nostra azienda. Il risultato è un materiale molto robusto, resistente ai graffi e facile da pulire.

The images are for illustrative purposes only and may not reflect the actual finish of the product, particularly when viewed through a screen. Therefore, the **SELECTION OF THE FINISHES** of the **BASES** and **MATTRESS FABRICS** must take place **AFTER CONSULTING** the **LUXURY BOX PHYSICAL SAMPLES** and the **COLOR CHARTS**.

Le immagini hanno valore puramente illustrativo e possono non rispecchiare la finitura reale del prodotto, in particolare se visualizzate attraverso uno schermo. Pertanto la **SELEZIONE DELLE FINITURE** delle **BASI** e dei **RIVESTIMENTI** dei **MATERASSI** deve avvenire **PREVIA CONSULTAZIONE** della **CAMPIONATURA FISICA** della **LUXURY BOX** e delle **CARTELLE COLORI**.

# ACCESSORIES UPON REQUEST ACCESSORI SU RICHIESTA

All tables have a standard setting customizable upon request.

Tutti i lettini hanno una configurazione standard personalizzabile su richiesta.



Mattress protection with polyurethane  
Coprilettino in spugna con poliuretano

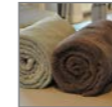

Luxury towel  
Telo Deluxe



Roll Holder  
Portarotolo

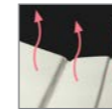

Heating system  
Riscaldamento



UK cable  
Cavo UK



USA cable  
Cavo USA



Plastic leg protection  
Protezione gambe in plastica



Customized mattress with logo  
Personalizzazione materasso con logo

# TECHNICAL REQUIREMENTS

## CARATTERISTICHE TECNICHE

ABSORPTION ASSORBIMENTO	VOLTAGE VOLTAGGIO	POWER POTENZA	FREQUENCY FREQUENZA	WARRANTY	GARANZIA
1,5 Amax (0,6 A)	100 Vac (240Vac)	150W	50/60 Hz	<i>Mattress heating: 1 year</i> <i>Electric parts and controls: 2 years</i> <i>Undeformable foam: 5 years</i> <i>Structure: 10 years</i>	Riscaldamento materasso: 1 anno Parti elettriche e comandi: 2 anni Gomma indeformabile: 5 anni Struttura: 10 anni

### REGULATIONS

All Equipment is  marked

#### Electrical equipment and beds

Directive 2006/42/CE (Machinery Directive) and national regulations

Directive 2014/30/UE (Electromagnetic Compatibility Directive) and national regulations.

#### Images

The images are for illustrative purposes only and may not reflect the actual image of the product.

### NORME

Tutte le attrezzature sono a marchio 

#### Attrezzature e lettini elettrici

Direttiva 2006/42/CE (Direttiva Macchine) e disposizioni nazionali di attuazione

Direttiva 2014/30/UE (Direttiva Compatibilità elettromagnetica) e disposizioni nazionali di attuazione.

#### Immagini

Le immagini hanno valore puramente illustrativo e possono non rispecchiare l'immagine reale del prodotto.

**Lemi**<sup>®</sup>  
ITALIAN WELLNESS EQUIPMENT

#### Brusaferrì & C srl

Via Mara Maretti Soldi, 13  
26011 Casalbuttano (CREMONA) ITALY  
Phone +39-0374-363069 Fax +39-0374-363071  
info@lemigroup.it service@lemigroup.it

www.lemigroup.it